



豐雅電子

客 戶: _____

(CUSTOMER)

承 認 書

(APPROVE SHEET)

名 稱: 不燃性金屬氧化皮膜電阻器

(DESCRIPTION) METAL OXIDE FILM RESISTOR(NONFLAMMABLE)

貴公司料號碼: _____

(CUSTOMER TYPE NO)

承認 APPROVED BY

豐 雅 電 子 (東 莞) 有 限 公 司

FONG YAELECTRONIC(DONG GUAN)CO.,LTD

地 址: 東 莞 市 石 碣 鎮 黃 泗 圍 工 業 區

HUANGSIWEI INDUSTRIAL AREA,SHIJIE,DONGGUAN,P.R.C.

TEL:86-769-86316268

FAX:86-769-86321078

Http:www.fongya.com.cn

公司名稱 Company Name	豐雅電子(東莞)有限公司 FONG YA ELECTRONIC(DONG GUAN)CO.,LTD.				
品名 Product Name	不燃性金屬氧化皮膜電阻器 METAL OXIDE FILM RESISTOR (NONFLAMMABLE)				
版本 Version	A/1	制定日期 Enactment Date	2013年04月23日 Apr 23, 2013	頁數 Page	13-1

1. 一般事項 General

1.1 適用 Scope

本承認書適用於豐雅電子(東莞)有限公司製造之[不燃性金屬氧化皮膜電阻器]，符合環境關聯物質要求之 RoHS 測試。

This specification is available for Metal Oxide Film Resistors manufactured by FONG YA ELECTRONIC(DONG GUAN)CO.,LTD, it accords with RoHS test of Environment related substance requirement.

1.2 形名(例) Type designation (example)

依使用種類、額定電力、公稱電阻值、容許誤差及型狀而區別,其構造如下。

The type designation shall be in the following form and as specified.

MOF	1/4 W	10K	±5%	T/B
種類 Type	額定電力 Rated power	公稱電阻值 Nominal resistance value	電阻值容許誤差 Resistance tolerance	形狀 Form
	標準 小型 Normal Small	E-24 Series	J ±5%	P 型 P Type
	1/4W 1/2WS	E-96 Series	G ±2%	MB 型 MB Type
	1/2W 1WS		F ±1%	M 型 M Type
	1W 2WS			MKK 型 MKKType
	2W 3WS			F 型 F Type
	3W 5WS			FK 型 FK Type
				FKK 型 FKK Type

1.3 額定電力 Rated power

額定電力係應在周圍溫度 70°C 可以連續負載的最大電力，如表-1;但周圍溫度如超過 70°C 時之額定電力則依圖一的電力遞減曲線實施。

Rated power is maximum power which can be continuously loaded at specified ambient temperature 70°C,as Table-1;however when the ambient temperature exceeds 70°C ,rated power should be determined from the derating curve of Fig.1.

公司名稱 Company Name	豐雅電子(東莞)有限公司 FONG YA ELECTRONIC(DONG GUAN)CO.,LTD.				
品名 Product Name	不燃性金屬氧化皮膜電阻器 METAL OXIDE FILM RESISTOR (NONFLAMMABLE)				
版本 Version	A/1	制定日期 Enactment Date	2013年04月23日 Apr 23, 2013	頁數 Page	13-2

表-1 Table-1

種類 Type	定格電力 Rated power	最高使用電壓 Maximum working voltage	最高過負荷電壓 Maximum overload voltage	耐電壓 Dielectric withstanding voltage	阻值範圍(Ω) Resistance Range(Ω)	
Normal size	MOF1/4W	0.25W	300V	500V	350V	0.1Ω~1MΩ
	MOF1/2W	0.5W	350V	600V	350V	0.1Ω~1MΩ
	MOF1W	1W	350V	1000V	600V	0.1Ω~1MΩ
	MOF2W	2W	350V	1000V	1000V	0.1Ω~1MΩ
	MOF3W	3W	500V	1000V	1000V	0.1Ω~1MΩ
Small size	MOF1/2WS	0.5W	300V	500V	350V	0.1Ω~1MΩ
	MOF1WS	1W	300V	600V	350V	0.1Ω~1MΩ
	MOF2WS	2W	350V	1000V	600V	0.1Ω~1MΩ
	MOF3WS	3W	350V	1000V	1000V	0.1Ω~1MΩ
	MOF5WS	5W	500V	1000V	1000V	0.1Ω~1MΩ

圖一 電力遞減曲線 Figure 1 Power derating curve

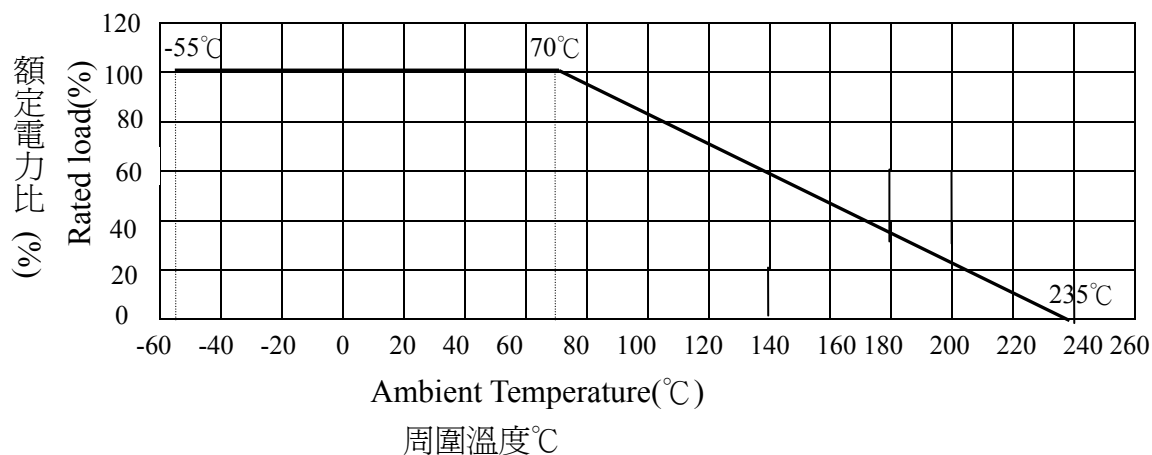

1.4 額定電壓 Rated voltage

額定電壓係指對應於額定電力的直流或交流(商用頻率之有效值)的電壓,由下式求得。

The rated voltage shall be the D.C. or A.C.(R.M.S. at power frequency) voltage which corresponds the rated power and the value of which is calculated from the formula below.

公司名稱 Company Name	豐雅電子(東莞)有限公司 FONG YA ELECTRONIC(DONG GUAN)CO.,LTD.				
品名 Product Name	不燃性金屬氧化皮膜電阻器 METAL OXIDE FILM RESISTOR (NONFLAMMABLE)				
版本 Version	A/1	制定日期 Enactment Date	2013年04月23日 Apr 23, 2013	頁數 Page	13-4

2.3 鐵帽端子 Terminal caps

鐵帽端子須確實地連接(電氣的及機械的)於電阻體上。

The caps shall be securely connected with the resistor element electrically and mechanically.

2.4 外裝色澤 Resistor body color

表-2 Table-2

普通型 Normal size		小型化 Small size	
種類 Type	顏色 Color	種類 Type	顏色 Color
MOF1/4W,MOF1/2W, MOF1W,MOF2W, MOF3W	灰色 Gray	MOF1/2WS,MOF1WS, MOF2WS,MOF3WS, MOF5WS	砖红 Pink

2.5 表示 Indication

參照本承認書的 [4. 表示]。

The indication shall be satisfied with [4. Indication].

3. 特性 Characteristics

表-3 Table-3

項目 Item	規格值 Performance	試驗方法(依據 JIS C 5202) Test methods(Conform to JIS C 5202)
溫度係數 Temperature Coefficient	$\pm 350\text{PPM}/^\circ\text{C}$ ($\pm 500\text{PPM}/^\circ\text{C} < 1\Omega$)	5.2 項參照 Comply with 5.2 $\frac{R_1 - R_0}{R_0(T_1 - T_0)} \times 10^6 (\text{PPM}/^\circ\text{C})$ R_0 :室溫(T_0)所測量之電阻值。 R_1 :室溫+100 $^\circ\text{C}$ (T_1)後所測量之電阻值。 R_0 :Resistance value at room temp.(T_0). R_1 :Resistance value at room temp.plus 100 $^\circ\text{C}$ (T_1)
短時間過負荷 Short time overload	$\pm(1\%+0.05\Omega)$ 以內。 不得有機械的損傷。 Within $\pm(1\%+0.05\Omega)$. No evidence of mechanical damage.	5.5 項參照 Comply with 5.5 額定電壓x2.5 倍,5 秒。 不可超過最高過負荷電壓(見表-1) Rated voltage x 2.5 times, 5s But not to exceed maximum overload voltage.(See table-1)

公司名稱 Company Name		豐雅電子(東莞)有限公司 FONG YA ELECTRONIC(DONG GUAN)CO.,LTD.			
品名 Product Name		不燃性金屬氧化皮膜電阻器 METAL OXIDE FILM RESISTOR (NONFLAMMABLE)			
版本 Version	A/1	制定日期 Enactment Date	2013年04月23日 Apr 23, 2013	頁數 Page	13-5
項目 Item	規格值 Performance	試驗方法(依據 JIS C 5202) Test methods(Conform to JIS C 5202)			
絕緣電阻 Insulation Resistance	10 ⁴ MΩ以上。 10 ⁴ MΩ or more.	5.6 項參照 Comply with 5.6 置於 V 型槽方法。 施加直流電壓 500V 60 秒。 V-block method Resistor shall be tested at DC 500V for 60 seconds.			
耐電壓 Dielectric Withstanding Voltage	無電弧放電、燒損及絕緣破壞等異狀。 No evidence of flashover mechanical damage, arcing or insulation breakdown.	5.7 項參照 Comply with 5.7 常壓,置於 V 型槽方法。 施加個別規定之交流電壓 60 秒。(見表-1) Constant pressure, V-block method Resistor shall be tested at AC potential respectively for 60 seconds. (See table-1)			
斷續過負荷 Pulse overload	±(2%+0.05 Ω)以內。 Within ±(1%+0.05 Ω)	5.8 項參照 Comply with 5.8 額定電壓×4 倍,10000 回(1 秒 ON,25 秒 OFF)。 不可超過最高斷續電壓(見表-1) Rated voltage X 4 times, 10000 cyc.(1s ON, 25s OFF) But not to exceed maximum pulse voltage. (See table-1)			
端子強度 Terminal strength	端子不得斷裂及鬆弛。 No evidence of mechanical damage.	6.1 項參照 Comply with 6.1			
		引張強度 Tensile strength	線徑 mm Diameter	引張力 Tensile force N(kgf)	時間 Time
			Φ0.38mm~0.50mm	5(0.51)	10±1 second
			Φ0.50mm~0.70 mm	10(1.02)	
		扭轉強度：自電阻體起約 6mm~6.5mm 處之端子線,以約 0.75mm 曲率半徑彎曲 90 度,其次由彎曲處向端子線先端 1.2±0.4mm 處挾定端子引出軸,作回轉軸,以約 5 秒時間沿直面回轉 360°再逆轉 360°,如此施行回逆轉 2 次,不可發生折斷及鬆動現象。 Tensional strength : To bend the lead wire at the point of about 6mm~6.5mm from resistor body. about 0.75mm curvature radii to 90°then catch the wire at 1.2±0.4mm apart from the bend point end and turn it (clockwise) by 360 degrees perpendicular to the resistor axis at speed of same 5 seconds per turn, and do the same counterclockwise again which constitute a whole turn. Repeat the turn for 2 times without causing any break and looseness.			

公司名稱 Company Name	豐雅電子(東莞)有限公司 FONG YA ELECTRONIC(DONG GUAN)CO.,LTD.				
品名 Product Name	不燃性金屬氧化皮膜電阻器 METAL OXIDE FILM RESISTOR (NONFLAMMABLE)				
版本 Version	A/1	制定日期 Enactment Date	2013年04月23日 Apr 23, 2013	頁數 Page	13-6
項目 Item	規格值 Performance	試驗方法(依據 JIS C 5202) Test methods(Conform to JIS C 5202)			
焊錫耐熱性 Resistance to soldering heat	±(1%+0.05Ω)以內。 不得有機械的損傷。 Within ±(0.5 %+0.05Ω) No evidence of mechanical damage.	6.4 項參照 Comply with 6.4 350±10°C, 3±1.0 秒, 試驗後放置半小時。 350±10°C, 3±1.0s After test leave for 0.5h.			
焊錫附著性 Solderability	導線至少 95%以上新錫覆蓋。 Covered with new solder by 95% at least.	6.5 項參照 Comply with 6.5 焊錫溫度：230±5°C。 浸錫時間：3±1.0 秒。 Test temperature of solder:230±5°C Dipping time in solder:3±1.0 s			
耐溶劑性 Resistance to solvent	塗裝及色碼不得脫落。 No deterioration of protective coating and markings.	6.9 項參照 Comply with 6.9 放入酒精溶劑之超音波機內，保持 3 分鐘。 Specimens shall be immersed in a bath of isoproalcohol completely for 3 minutes with ultrasonic.			
溫度循環 Temperature cycle	±(2%+0.05Ω)以內。 不得有機械的損傷。 Within ±(1%+0.05Ω) No evidence of mechanical damage.	7.4 項參照 Comply with 7.4 低溫側：-55°C/30 分, 室溫：10~15 分鐘 高溫側：+80°C/30 分, 室溫：10~15 分鐘 5 回 Low side：-55°C/30min, Room temp.：10 to 15min High side：80°C/30min, Room temp.：10 to 15min 5 cycles			
耐濕負荷壽命 Load life in humidity	±(5%+0.05Ω)以內。 Within ±(2%+0.05Ω)	7.9 項參照 Comply with 7.9 40±2°C, 濕度 90~95%, 1000 小時 定格電壓(90 分鐘 ON, 30 分鐘 OFF) 40±2°C, 90 to 95%RH, 1000h Rated voltage (90 min ON, 30 min OFF)			
負荷壽命 Load life	±(5%+0.05Ω)以內。 Within ±(2%+0.05Ω)	7.10 項參照 Comply with 7.10 70±3°C, 1000 小時 定格電壓(90 分鐘 ON, 30 分鐘 OFF) 70±3°C, 1000h Rated voltage (90 min ON, 30 min OFF)			

公司名稱 Company Name	豐雅電子(東莞)有限公司 FONG YA ELECTRONIC(DONG GUAN)CO.,LTD.				
品名 Product Name	不燃性金屬氧化皮膜電阻器 METAL OXIDE FILM RESISTOR (NONFLAMMABLE)				
版本 Version	A/1	制定日期 Enactment Date	2013年04月23日 Apr 23, 2013	頁數 Page	13-7

4. 表示 Indication

色碼 Color Code

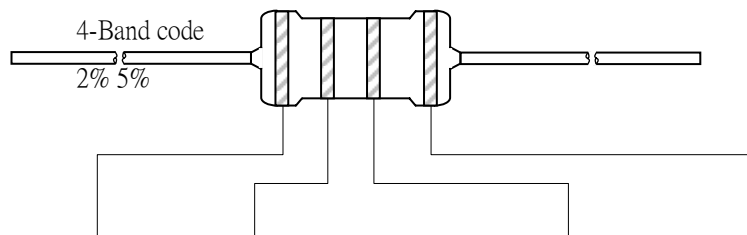

顏色 Color	第1數字 1 st figure	第2數字 2 nd figure	第3數字 3 RD figure	倍率 Multiplier	誤差率 Tolerance
黑 Black	0	0	0	10 ⁰	
棕 Brown	1	1	1	10 ¹	±1% (F)
紅 Red	2	2	2	10 ²	±2% (G)
橙 Orange	3	3	3	10 ³	
黃 Yellow	4	4	4	10 ⁴	
綠 Green	5	5	5	10 ⁵	
藍 Blue	6	6	6	10 ⁶	
紫 Violet	7	7	7	10 ⁷	
灰 Gray	8	8	8		
白 White	9	9	9		
金 Gold				10 ⁻¹	±5% (J)
銀 Silver				10 ⁻²	
無 Plain					

公司名稱 Company Name	豐雅電子(東莞)有限公司 FONG YA ELECTRONIC(DONG GUAN)CO.,LTD.				
品名 Product Name	不燃性金屬氧化皮膜電阻器 METAL OXIDE FILM RESISTOR (NONFLAMMABLE)				
版本 Version	A/1	制定日期 Enactment Date	2013年04月23日 Apr 23, 2013	頁數 Page	13-8

5. 外形寸法 External dimensions

5.1 散裝P型 P type

P Type

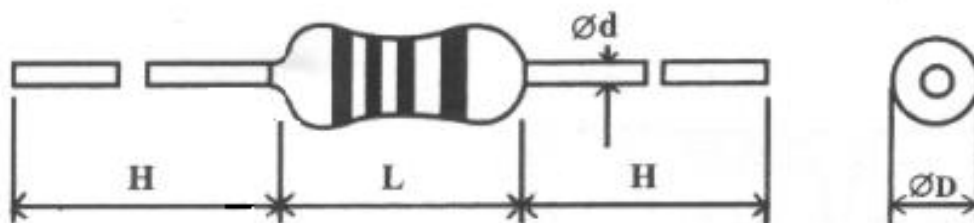

單位：mm

Unit：mm

種類 Type		尺寸 Dimensions			
普通型 Normal Size	小型化 Small Size	L	ϕD	ϕd	H
MOF1/4W	MOF1/2WS	6.5±1.0	2.3±1.0	0.48±0.05	26.0±2.0
MOF1/2W	MOF1WS	9.0±1.0	3.2±1.0	0.52±0.05	25.0±2.0
MOF1W	MOF2WS	11.0±1.0	4.5±1.0	0.70±0.05	30.0±2.0
MOF2W	MOF3WS	15.0±1.0	5.0±1.0	0.70±0.05	33.0±2.0
MOF3W	MOF5WS	17.0±1.0	6.0±1.0	0.70±0.05	33.0±2.0

公司名稱 Company Name	豐雅電子(東莞)有限公司 FONG YA ELECTRONIC(DONG GUAN)CO.,LTD.				
品名 Product Name	不燃性金屬氧化皮膜電阻器 METAL OXIDE FILM RESISTOR (NONFLAMMABLE)				
版本 Version	A/1	制定日期 Enactment Date	2013年04月23日 Apr 23, 2013	頁數 Page	13-9

5.2 帶裝 Axial Lead Taping

Txx Type

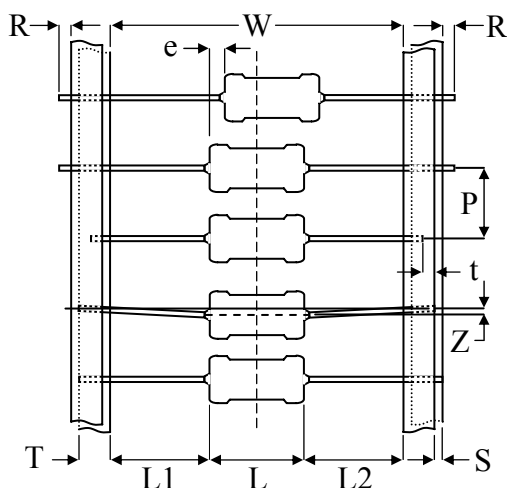

單位：mm
Unit：mm

種類 Type		帶狀 Taping	尺寸 Dimensions									
普通型 Normal Size	小型化 Small Size		L	W	P	L1-L2 Max.	T	Z Max.	R Max.	t Max.	e Max.	S Max.
MOF1/4W	MOF1/2WS	T26	6.5±1.0	26±1.0	5±0.5	0.5	6±0.5	1.2	0	3.0	0.6	0.5
		T52	6.5±1.0	52±1.0	5±0.5	1.0	6±0.5	1.2	0	3.0	0.6	0.5
MOF1/2W	MOF1WS	T52	9.0±1.0	52±1.0	5±0.5	1.0	6±0.5	1.2	0	3.0	0.6	0.5
MOF1W	MOF2WS	T52	11.0±1.0	52±1.0	5±0.5	1.0	6±0.5	1.2	0	3.0	0.6	0.5
		T63	11.0±1.0	63±1.0	5±0.5	1.0	6±0.5	1.2	0	3.0	0.6	0.5
MOF2W	MOF3WS	T73	15.0±1.0	73±1.0	5±0.5	1.0	6±0.5	1.2	0	3.0	0.6	0.5
MOF3W	MOF5WS	T73	17.0±1.0	73±1.0	10±0.5	1.0	6±0.5	1.2	0	3.0	0.6	0.5

公司名稱
Company Name

豐雅電子(東莞)有限公司
FONG YA ELECTRONIC(DONG GUAN)CO.,LTD.

品名
Product Name

不燃性金屬氧化皮膜電阻器
METAL OXIDE FILM RESISTOR (NONFLAMMABLE)

版本
Version

A/1

制定日期
Enactment Date

2013年04月23日
Apr 23, 2013

頁數
Page

13-10

5.3 MB型&M型&MKK型 MB Type &M Type& MKK Type

MB

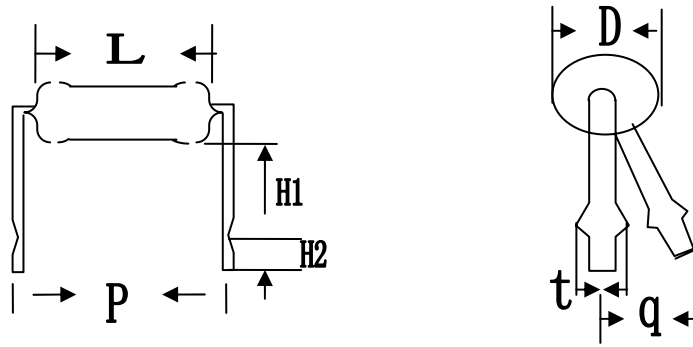

瓦特數 Watts	尺寸 Dimensions (mm)							
	D±1.0	L±1.0	P±1.0	H1±1.0	H2±1.0	d±0.05	t±0.15	qMax
1/2w,1ws	3.2	9.0	12.5	7	5	0.60	1.2	3
1w,2ws	4.5	11.0	15	7	5	0.75	1.25	3
2w,3ws	5.0	15.0	20	7	5	0.75	1.25	3

M

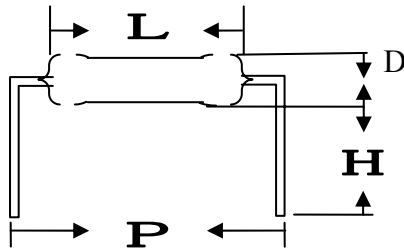

瓦特數 Watts	尺寸 Dimensions (mm)			
	ΦD	L	P±1.0	H±1.0
1/8w,1/6w	1.7±1.0	3.2±1.0	6	8
1/4w,1/2ws	2.3±1.0	6.5±1.0	10	8
1/2w,1ws	3.2±1.0	9.0±1.0	12.5	8
1w,2ws	4.5±1.0	11.0±1.0	15	10
2w,3ws	5.0±1.0	15.0±1.0	20	10
3w	6.0±1.0	17.0±1.0	25	10

MKK

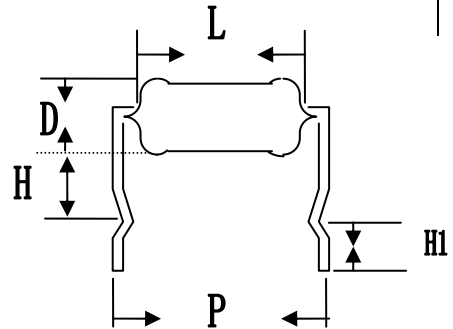

瓦特數 Watts	尺寸 Dimensions (mm)				
	D±1.0	L±1.0	P±1.0	H±1.0	H1±1.0
1/2w,1ws	3.2	9.0	12.5	7	5
1w,2ws	4.5	11.0	15	7	5
2w,3ws	5.0	15.0	20	7	5

公司名稱 Company Name	豐雅電子(東莞)有限公司 FONG YA ELECTRONIC(DONG GUAN)CO.,LTD.				
品名 Product Name	不燃性金屬氧化皮膜電阻器 METAL OXIDE FILM RESISTOR (NONFLAMMABLE)				
版本 Version	A/1	制定日期 Enactment Date	2013年04月23日 Apr 23, 2013	頁數 Page	13-11

5.4 F型&FK型&FKK型 F Type &FK Type&FKK Type

F

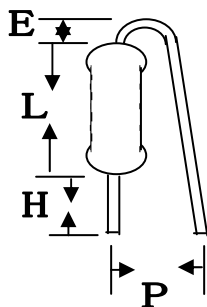

FK

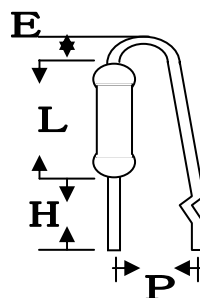

特數 Watts	尺寸 Dimensions (mm)				
	$\Phi D \pm 1.0$	$L \pm 1.0$	$P \pm 2.0$	E Max	$H \pm 1.0$
1/2w,1ws	3.2	9.0	8.0	3.5	5-8
1w,2ws	4.5	11.0	8.0	3.5	5-8
2w,3ws	5.0	15.0	8.0	3.5	5-8
3w	6.0	17.0	8.0	3.5	5-8

瓦特數 Watts	尺寸 Dimensions (mm)				
	$\Phi D \pm 1.0$	$L \pm 1.0$	$P \pm 2.0$	E Max	$H \pm 1.0$
1/2w,1ws	3.2	9.0	8.0	3.5	5-8
1w,2ws	4.5	11.0	8.0	3.5	5-8
2w,3ws	5.0	15.0	8.0	3.5	5-8
3w	6.0	17.0	8.0	3.5	5-8

FKK

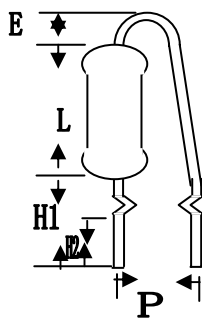

瓦特數 Watts	尺寸 Dimensions(mm)					
	$D \pm 1.0$	$L \pm 1.0$	$P \pm 1.0$	E Max	$H1 \pm 1.0$	$H2 \pm 1.0$
1/2w,1ws	3.2	9.0	8.0	3.5	5	4.0
1w,2ws	4.5	11.0	8.0	3.5	6	4.0
2w,3ws	5.0	15.0	8.0	3.5	6	4.0
3w	6.0	17.0	8.0	3.5	6	4.0

公司名稱 Company Name	豐雅電子(東莞)有限公司 FONG YA ELECTRONIC(DONG GUAN)CO.,LTD.				
品名 Product Name	不燃性金屬氧化皮膜電阻器 METAL OXIDE FILM RESISTOR (NONFLAMMABLE)				
版本 Version	A/1	制定日期 Enactment Date	2013年04月23日 Apr 23, 2013	頁數 Page	13-12

6 包裝 Package

6.1 帶裝品包裝 Tape in box packing (Ammo packing)

6.1.1 表示項目 Indication

- (1) 產品規格 Product specification
- (2) 數量 Quantity

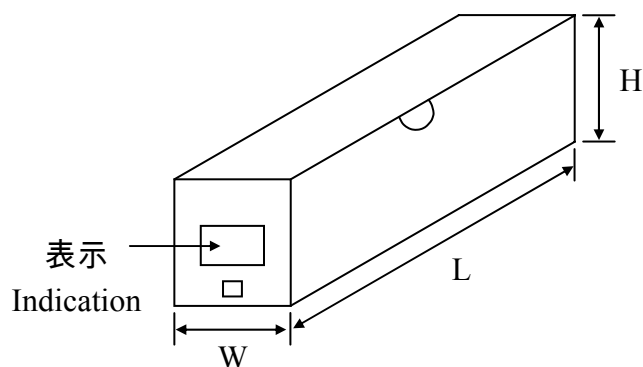

6.1.2 包裝盒尺寸和數量

Packing box size and quantity

種類 Type		形狀 Form	包裝數量 Quantity	尺寸 Dimensions (mm)		
普通型 Normal Size	小型化 Small Size			L	W	H
MOF1/4W	MOF1/2WS	T26	5000 PCS	260	50	100
		T52	5000 PCS	260	85	110
MOF1/2W	MOF1WS	T52	2000 PCS	260	80	85
MOF1W	MOF2WS	T52	1000 PCS	260	80	85
		T63	1000 PCS	260	90	85
MOF2W	MOF3WS	T73	1000 PCS	260	100	100
MOF3W	MOF5WS	T73	500PCS	260	100	100

公司名稱 Company Name	豐雅電子(東莞)有限公司 FONG YA ELECTRONIC(DONG GUAN)CO.,LTD.				
品名 Product Name	不燃性金屬氧化皮膜電阻器 METAL OXIDE FILM RESISTOR (NONFLAMMABLE)				
版本 Version	A/1	制定日期 Enactment Date	2013年04月23日 Apr 23, 2013	頁數 Page	13-13

6.2 散裝品包裝 Tape in box Bulk (Ammo Bulk)

6.2.1 表示項目 Indication

- (1) 產品規格 Product specification
- (2) 數量 Quantity

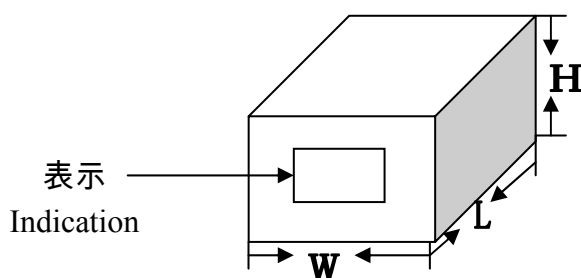

6.2.2 包裝盒尺寸和數量

Packing box size and quantity

種類 Type		形狀 Form	包裝數量 Quantity	尺寸 Dimensions (mm)		
普通型 Normal Size	小型化 Small Size			L	W	H
MOF1/4W	MOF1/2WS	P	10000 PCS	250	140	80
		成型 Molding	10000 PCS	250	140	80
MOF1/2W	MOF1WS	P	3000 PCS	200	130	80
		成型 Molding	5000 PCS	200	130	80
MOF1W	MOF2WS	P	1000 PCS	200	130	80
		成型 Molding	2000 PCS	200	130	80
MOF2W	MOF3WS	P	1000 PCS	200	130	80
		成型 Molding	1000 PCS	200	130	80
MOF3W	MOF5WS	P	250PCS	200	130	80
		成型 Molding	250PCS	200	130	80

料號說明

Explanation of part number

電阻項目 Resistor Item		功率 Power Rated											
Code	產品項目 Products Item	Code	Rated	Code	Rated	Code	Rated	Code	Rated	Code	Rated	Code	Rated
30	Metal Oxide Film Fixed Resistor	1	1/8W	2	1/4W	3	1/2W	4	1W	5	2W	6	3W
3S	Metal Oxide Film Fixed Resistor (Mini)	7	5W										



包裝形態 Suffix For Packaging	
Code	Packaging
T	帶式
F	立式
H	臥式
B	散裝

尺寸 Taping(mm)	
Code	Taping
1	26mm
2	52mm
3	63mm
4	73mm
5	立式、臥式、散裝

容許值 Tolerance	
Code	Tolerance
F	±1%
G	±2%
J	±5%

電阻值 Resistance Value	
1. R 指示歐姆小數點位置 例:4.7 Ohm=4R70	Decimal Point Is Expressed By R As 4.7 Ohm=4R70
2. K 指示歐姆小數點位置 例:4.7K Ohm=4K70	Decimal Point Is Expressed By R As 4.7K Ohm=4K70
3. R 指示歐姆小數點位置 例:4.7M Ohm=4M70	Decimal Point Is Expressed By R As 4.7M Ohm=4M70
	Decimal Point Is Expressed By R As 4.7MOhm=4M70

● 品名構成 Product Identification

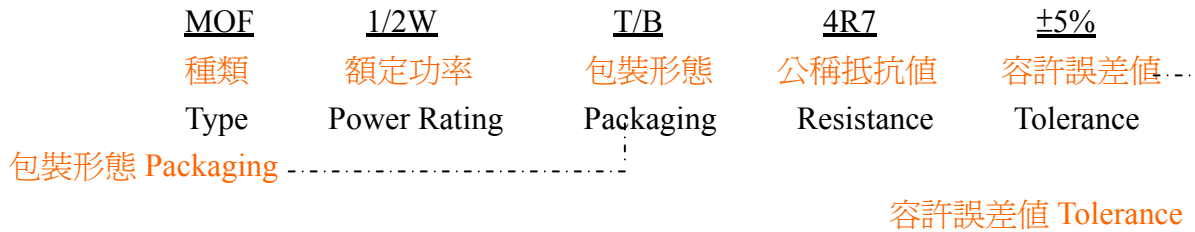

T/B	T26	F	FK 型	FK1 型
FK2 型	FKK 型	M 型	MB 型	MKK 型

F	G	J
±1%	±2%	±5%